

ROTATOR GR-40

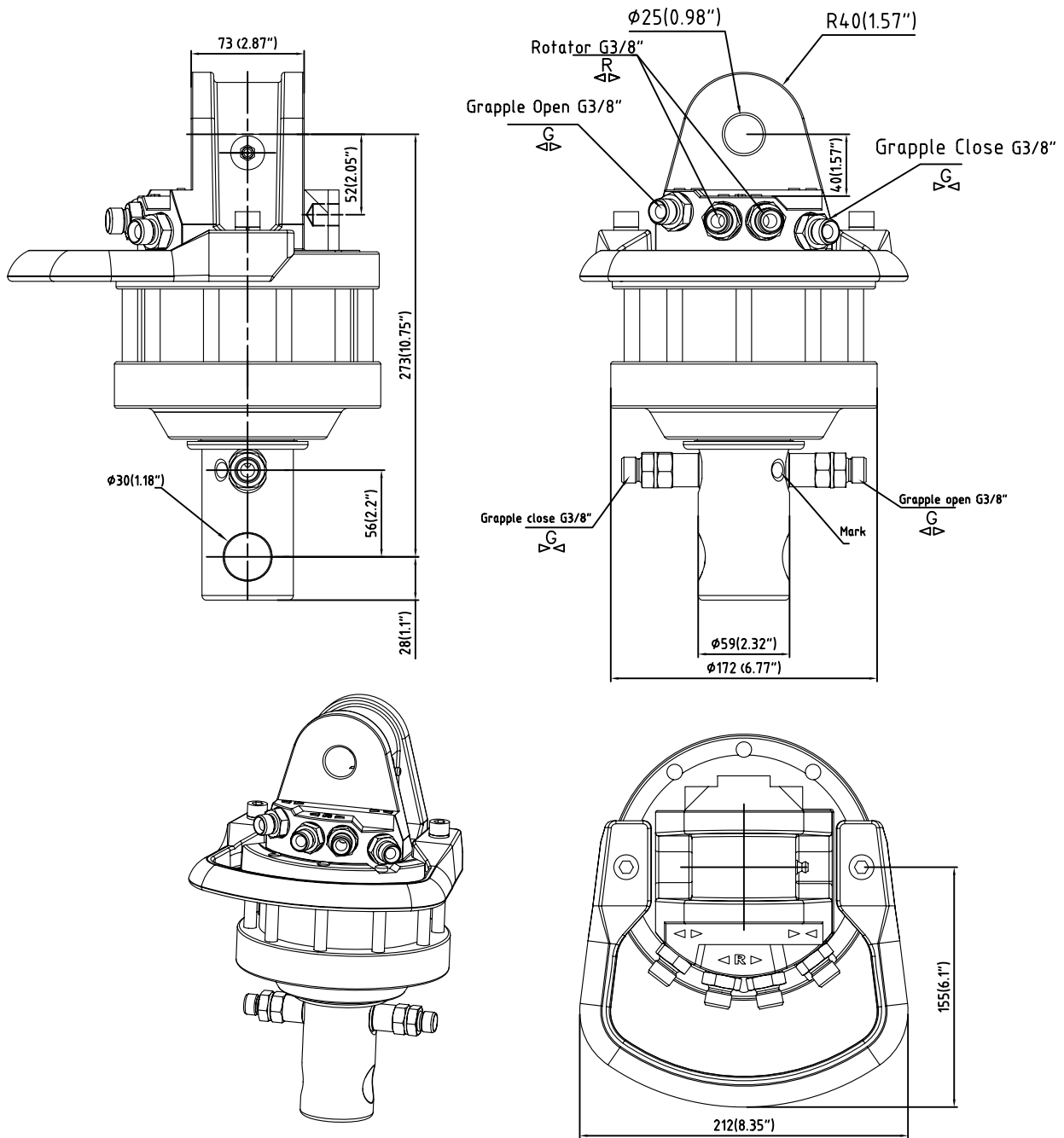

Technical data

Rotation :		Unlimited
Max axial load static,KN:		40
Max axial load dynamic,KN:		20
Torque (25MPa) ,Nm:		1100
Rated displacement,ml/r:		420
Weight,Kg:		23
Max working pressure		connection
Rotator :	←R→ max 25MPa	G3/8"
Grapple/Tool open :	←G→ max 20MPa	G3/8"
Grapple/Tool close:	←G→ max 30MPa	G3/8"